



AUTOMOTIVE RECTIFIER

RAL2505 THRU RAL2510

VOLTAGE RANGE
CURRENT

50 to 1000 Volts
25.0 Ampere

FEATURES

- Low Leakage
- Low forward voltage drop
- High current capability
- High forward surge current capacity
- High temperature soldering guaranteed:
260 /10 seconds, 0.375" (9.5mm) lead length

MECHANICAL DATA

- Case: transfer molded plastic
- Epoxy:UL94V-0 rate flame retardant
- Lead: Plated lead, solderable per MIL-STD-202E method 208C
- Polarity: color ring denotes cathode end
- Mounting Position: any
- Weight: 0.11 ounce, 3.0 gram

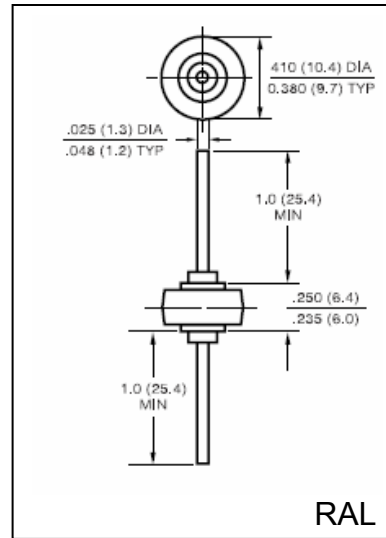

MAXIMUM RATINGS AND ELECTRICAL CHARACTERISTICS

- Ratings at 25°C ambient temperature unless otherwise specified
- Single Phase, half wave, 60Hz, resistive or inductive load
- For capacitive load derate current by 20%

	SYMBOLS	RAL 2505	RAL 251	RAL 252	RAL 254	RAL 256	RAL 258	RAL 2510	UNIT
Maximum Repetitive Peak Reverse Voltage	V_{RRM}	50	100	200	400	600	800	1000	Volts
Maximum RMS Voltage	V_{RMS}	35	70	140	280	420	560	700	Volts
Maximum DC Blocking Voltage	V_{DC}	50	100	200	400	600	800	1000	Volts
Maximum Average Forward Rectified Current, 0.375" (9.5mm) lead length at $T_A = 60^\circ C$	$I_{(AV)}$	25.0							Amps
Peak Forward Surge Current	I_{FSM}	500							Amps
8.3mS single half sine wave superimposed on rated load (JEDEC method)									
Maximum Instantaneous Forward Voltage @ 25.0A	V_F	1.0							Volts
Maximum DC Reverse Current at Rated $T_A = 25^\circ C$	I_R	5.0							μA
DC Blocking Voltage per element $T_A = 100^\circ C$		250							
Typical Thermal Resistance	$R_{\theta JC}$	1.0							$^\circ C/W$
Operating Junction Temperature Range	T_J	(-65 to +175)							$^\circ C$
Storage Temperature Range	T_{STG}	(-65 to +175)							$^\circ C$



RATINGS AND CHARACTERISTIC CURVES RAL2505 THRU RAL2510

FIG.1-TYPICAL FORWARD CURRENT

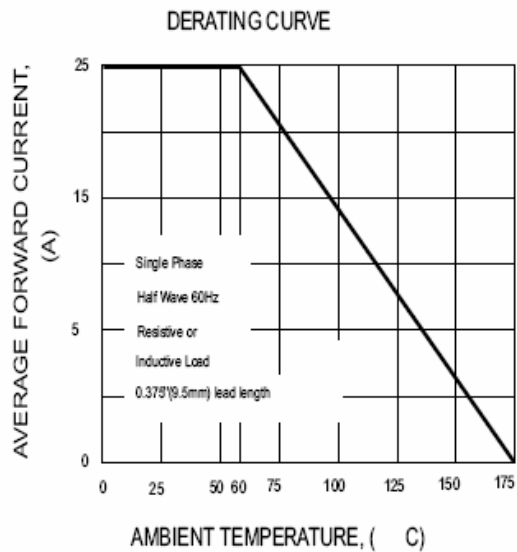

FIG.2-MAXIMUM NON-REPETITIVE PEAK

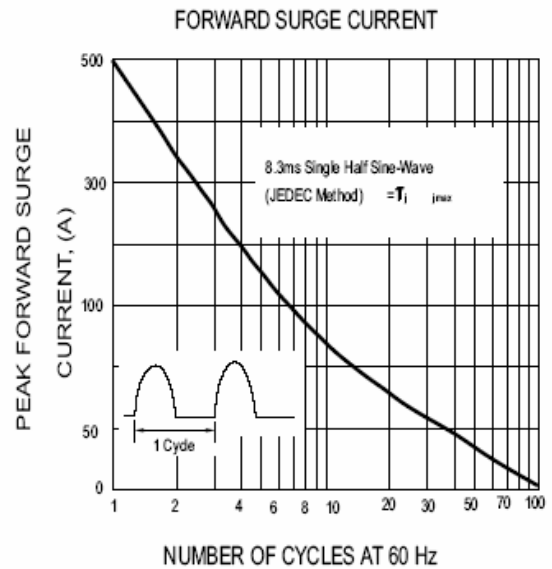

FIG.3-TYPICAL INSTANTANEOUS
FORWARD CHARACTERISTICS

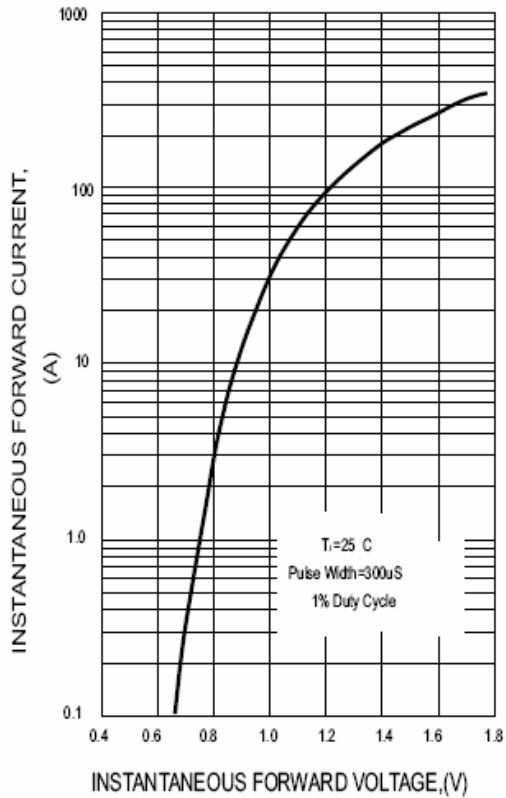

FIG.4. FORWARD POWER DISSIPATION

